

# Development of an Electric Wheelchair System Using PEM Fuel Cell

Kazuo Saito, Chan Anyapo, Pitak Kamjitjam, and Toshihiko Noguchi

Department of Electrical Engineering, Nagaoka University of Technology, [saito@vos.nagaokaut.ac.jp](mailto:saito@vos.nagaokaut.ac.jp)

## Abstract

*This paper describes an electric wheelchair using a fuel cell and its speed characteristics. The wheelchair system has a PEM fuel cell stack as a power supply, an EDLC bank as an energy buffer, and a newly designed four-quadrant DC chopper which drives two DC motors. Drive performance of the wheelchair and essential characteristics of the fuel cell are investigated by experimental results. Consequently, it is shown that the wheelchair satisfies basic driving operations, and also the PEM fuel cell has sufficient capability for the wheelchair system. Therefore, the ideas and technologies which are applied to the system will be able to contribute to future electric vehicles and transportation.*

## Keywords

*electric wheelchair, PEM fuel cell, DC motor, four-quadrant DC chopper, EDLC*

## 1. INTRODUCTION

Recently, discussions on fuel cells have increased significantly. Regarding problems of the global environment and exhaustion of natural resources, the study of an application of fuel cells is noteworthy [Hoogers, 2003], [Larminie, 2003]. Besides, several types of electric vehicles using fuel cells have been developed by car manufacturers and institutes [Iizuka, 2006]. Therefore, a combination of fuel cells and electric vehicles or wheelchairs is meaningful topic [Yamaguchi et al., 2007].

Furthermore, there is an increasing problem of the aging society, especially in Japan. From this viewpoint, the study of wheelchairs is both important and in urgent need.

This paper introduces an electric wheelchair that uses a PEM (Proton Exchange Membrane) fuel cell. The wheelchair system has an EDLC (Electric Double Layer Capacitor) bank as an energy buffer, and a four-quadrant DC chopper which drives two DC motors. The motors are mounted on both of the back wheels, and speed detectors are installed on both of the back tires. Essential characteristics of the PEM fuel cell and the electric wheelchair system are investigated in this paper. [Anyapo et al., 2006], [Saito et al., 2006], [Kamjitjam et al., 2007], [Saito et al., 2008].

## 2. STRUCTURE OF WHEELCHAIR

Figure 1 shows a photograph of the electric wheelchair

which originally has the following specifications; the diameter of each back wheel is 22 inches, the maximum speed is 6km/h, the output power of each DC motor is 90W, and the power supply is a Li-ion battery (25.9V-6Ah). The electric wheelchair has been improved on several points. In particular, the power supply is replaced by the PEM fuel cell stack with the hydrogen storage alloys, which are seen in Fig. 2 (front side: the fuel cell).



**Fig. 1** Electric wheelchair

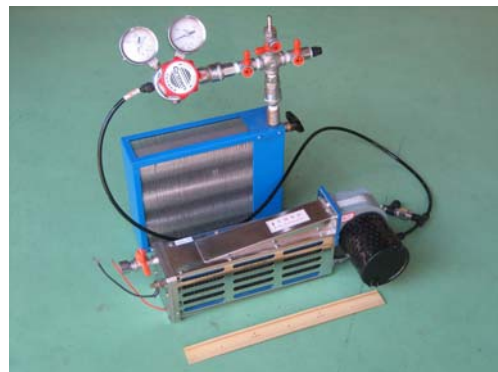

**Fig. 2** PEM fuel cell and hydrogen storage alloys

The two DC motors are driven by the newly designed four-quadrant DC chopper, and the EDLC bank is employed as an energy buffer managing energy flow of the system. The major specifications of them are as follows;

- (1) PEM fuel cell: 200W-24V (output),
- (2) Hydrogen storage alloys: 500L (capacity of H<sub>2</sub>),
- (3) DC motor: 90W (output power each),
- (4) EDLC: 1350F-2.7V (capability/ 1 piece).

Figure 3 shows the control system of the electric wheelchair. A user of the wheelchair handles only a joy-stick which can select a drive mode (forward, backward, right/left turn, and pivot). The energy control and motor drive circuit work depending on signals from the joy-stick. Then, the two DC motors mounted on both of the back wheels are driven by the chopper for the commanded drive mode. Figure 3 also indicates that the PEM fuel cell is the power supply, EDLC is the energy storage device, and the two DC motors drive the wheels of the wheelchair.

Management of energy flow and the motor drive circuit of the wheelchair system are illustrated in Fig. 4. In terms of the PEM fuel cell, hydrogen is supplied from the hydrogen storage alloys, and oxygen in the air is inhaled using a blower DC motor.

The EDLC bank is charged or discharged depending on the drive conditions of the wheelchair system. For example, the EDLC supplies energy to the two motors when the output power of the fuel cell lacks for motor drive. When regeneration of the motors occurs, normally the EDLC is charged. Figure 5 illustrates two examples of energy flow; (a) indicates the energy flows from the fuel cell to the motors, and a part of the energy can charge the EDLC. Figure 5 (b) shows the regeneration; the energy flows from the motors to the EDLC (mode 1), or a discharging resistor ( $R_d$ ) works to dissipate the energy if the EDLC is fully charged (mode 2)

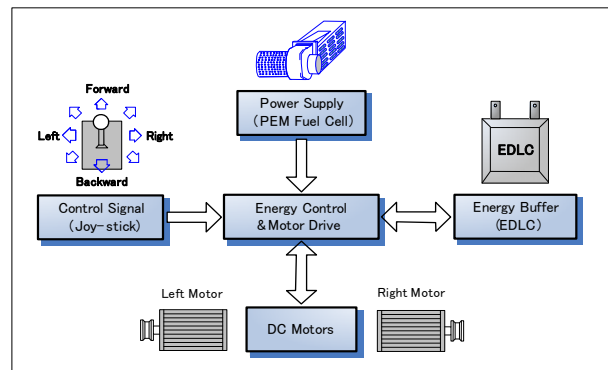

**Fig. 3** Control system of the electric wheelchair

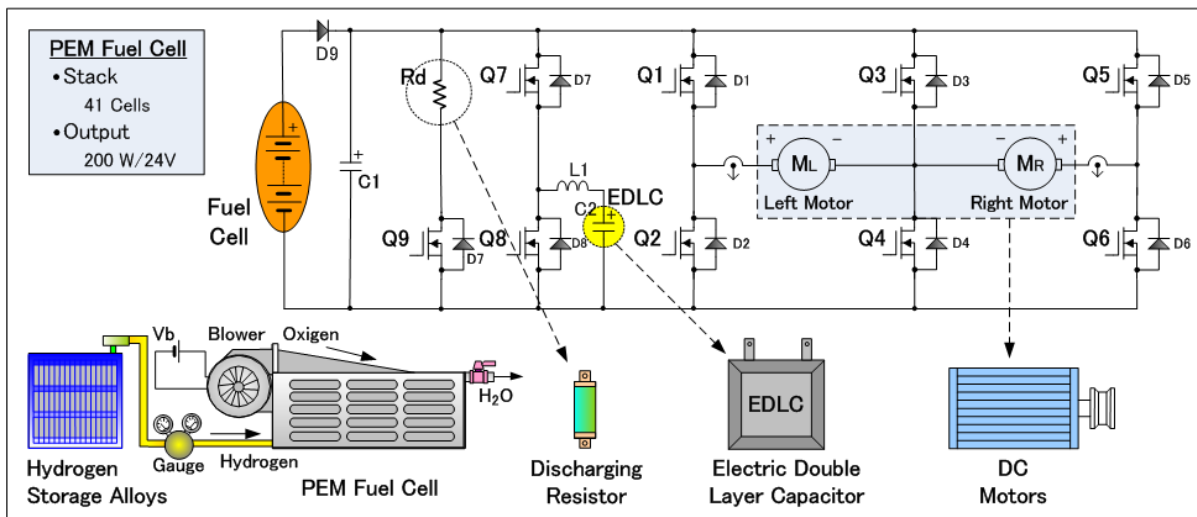

**Fig. 4** Management of energy flow and the motor drive circuit

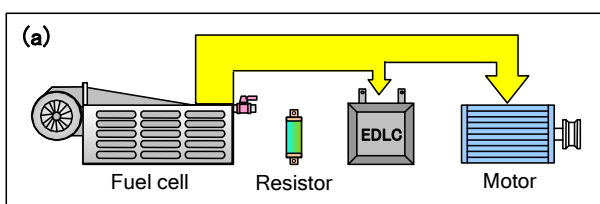

(a) Motoring mode

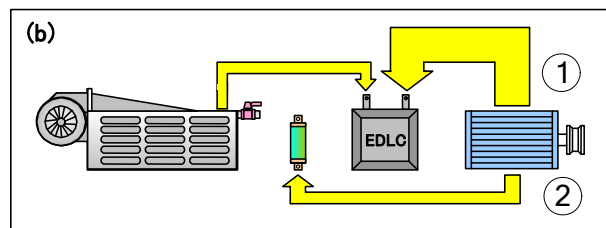

(b) Regeneration mode

**Fig. 5** Examples of energy flow among the main devices

### 3. CHARACTERISTICS OF FUEL CELL

Several types of fuel cells have been developed and applied in many fields, above all things, PEM fuel cells are the most suitable for electric vehicles or electric wheelchairs, because PEM fuel cells can be used at room temperature and the sizes are small.

The hydrogen storage alloys is connected with the PEM fuel cell, as illustrated in Fig. 4. This figure also shows the flow of hydrogen and oxygen by the use of arrows. By the electrochemical reactions, only water vapor is exhausted.

Figure 6 demonstrates the characteristics of the PEM fuel cell obtained by experiments. As load (output current) increases, output voltage gradually drops. Meanwhile the maximum output power reaches around 200W.

Figure 7 and Figure 8 show the experimental results for the output power of the PEM fuel cell, when the forward mode and the left turn mode are carried out. As shown in Fig. 7, the maximum output power reaches 100W, and the steady state value is about 55W. In Fig. 8, the correspondent values are 105W and 45W, respectively. In addition, the output power is about 30W when the two motors do not work (indicated “stop”). The reason for this is that the blower is working, i. e., the PEM fuel cell is also used as the power supply of the blower motor which inhales oxygen from the air.

These data assure that the PEM fuel cell has sufficient capability for the electric wheelchair system.

### 4. PERFORMANCE OF WHEELCHAIR

The electric wheelchair has several drive modes; forward, backward, right/left turn, and pivot mode. The motors mounted on both of the back wheels are driven by the four-quadrant DC chopper which is designed to simplify the motor drive system. To measure the velocities of the wheels, speed detectors are installed on both of the back tires.

#### 4.1 Four-quadrant DC chopper

The four-quadrant DC chopper, which drives the two DC motors, has a combined structure of two full-bridge choppers. Therefore, the number of switching devices can be reduced from eight to six, as illustrated in Figs. 4 and 9.

Figure 9 illustrates the operating condition of the DC chopper in the forward mode. Thick arrows indicate the current path of the two DC motors and the switching devices (MOSFETs). In the case of the forward mode,  $Q_1$  &  $Q_5$  and also  $Q_4$  have PWM switching conditions.

Figure 10 shows the waveforms of the DC chopper in the forward mode. The PWM switching frequency of  $Q_1, Q_2, Q_5, Q_6$  is 10kHz, and that of  $Q_3, Q_4$  is 1kHz. When  $Q_4$  is ON condition and  $Q_1$  &  $Q_5$  are in switching operations, the two DC motors rotate in a forward direction at once. Figure 10 also describes the voltage waveforms of the left motor ( $V_{L(ave)}$ ) and the right motor ( $V_{R(ave)}$ ) of the wheels, which are working in chopper operation. Thus, the electric wheelchair moves forward.

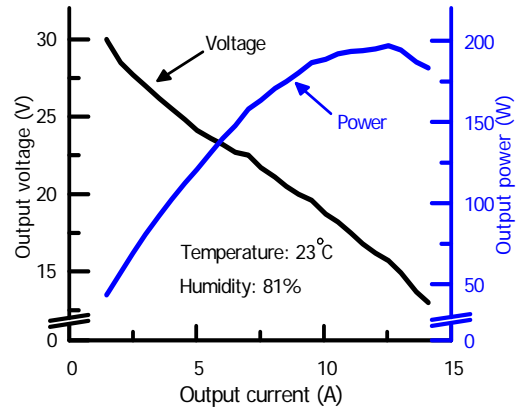

Fig. 6 Characteristics of the PEM fuel cell

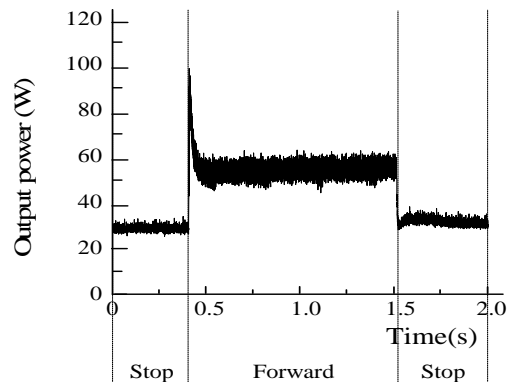

Fig. 7 Output power of the PEM fuel cell (Forward)

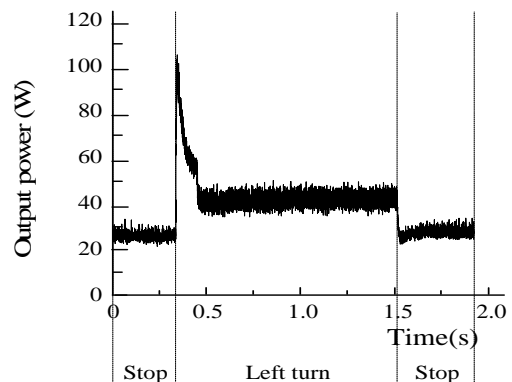

Fig. 8 Output power of the PEM fuel cell (Left turn)

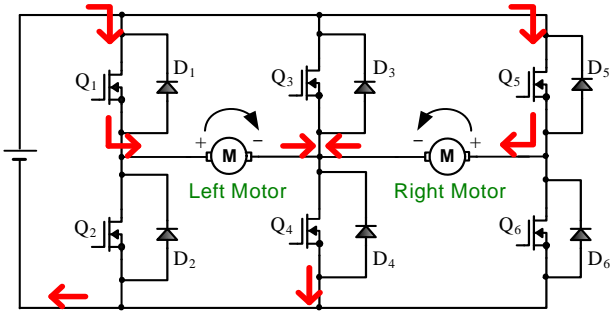

Fig. 9 Operation of the DC chopper (Forward)

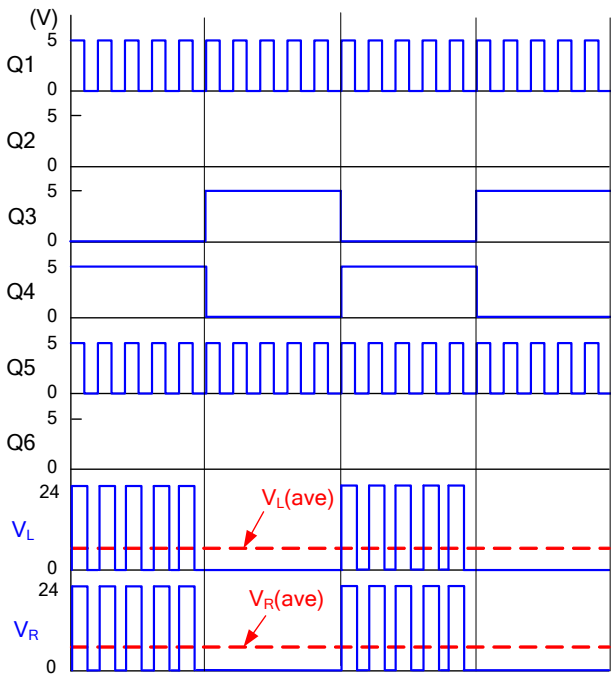

Fig. 10 Waveforms of the DC chopper (Forward)

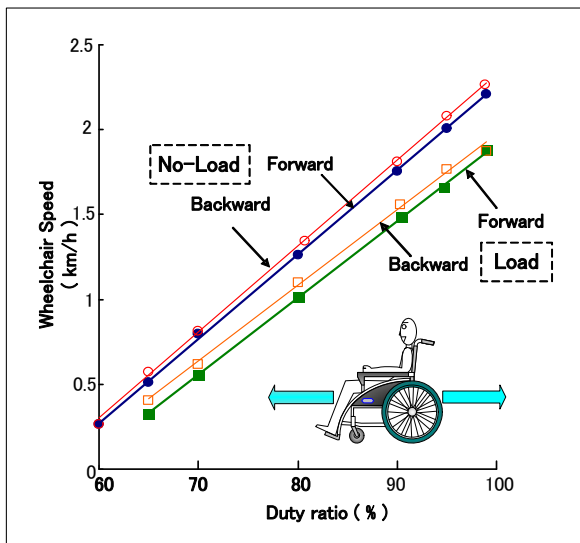

Fig. 11 Wheelchair speed to switching duty ratio

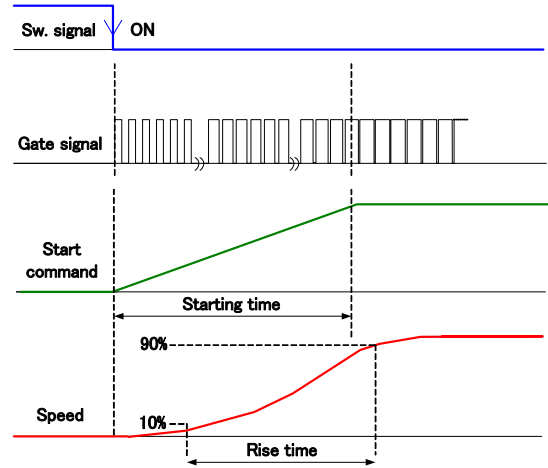

Fig. 12 Definition of starting time and rise time

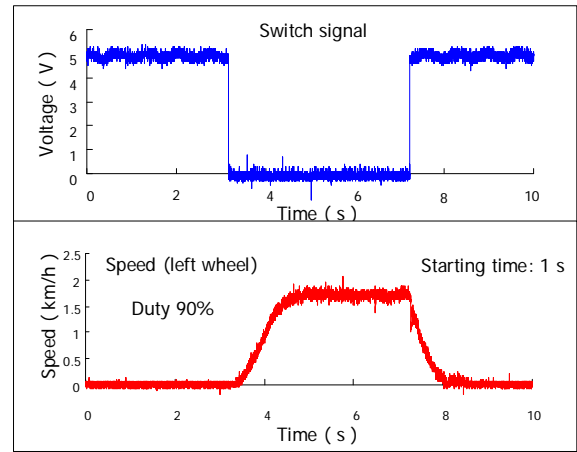

Fig. 13 Switch signal and wheelchair speed (Forward)

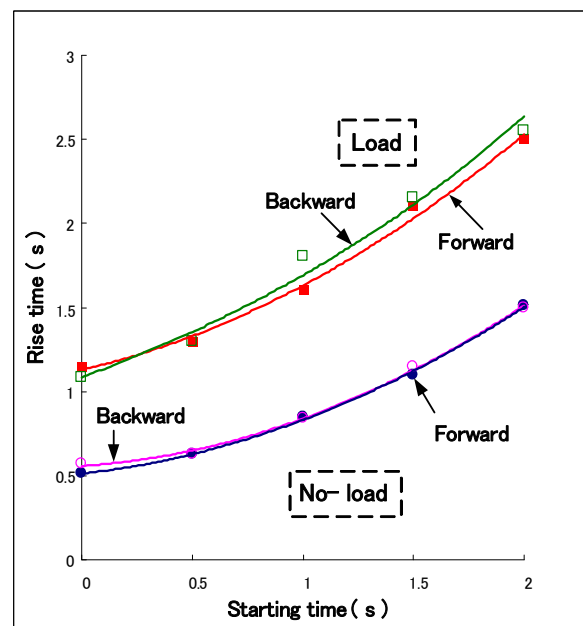

Fig. 14 Rise time to starting time

#### 4.2 Speed data by experiments

Figure 11 shows the wheelchair speeds for the forward and the backward modes under both the conditions of a load (a user who weighs 75kg) and no-load. From these data, it is shown that the wheelchair speeds increase linearly as the switching duty ratios of  $Q_1$  &  $Q_5$  (in the case of the forward mode) or  $Q_2$  &  $Q_6$  (in the case of the backward mode) become higher.

In order to investigate a smooth start drive which enables the wheelchair to move slowly, the starting time and the rise time are defined as indicated in Fig. 12.

When a switch signal is sent from the joy-stick, a start command rises gradually so that a sudden movement does not occur. Then, the wheelchair speed increases smoothly, where the time between 10% and 90% of the constant speed is defined as the rise time.

Figure 13 shows an experimental result of a switch signal and a wheelchair speed when the starting time is 1s. Before the speed rises, delay time (0.35s) is observed,

which is caused by friction between the tires and ground. In this case, the conditions are as follows; forward mode, no-load, and the switching duty ratio of  $Q_1$  &  $Q_5$  is 90%. The rise time at the load condition is larger than the no-load one, which is caused by the difference of inertias. For drive feeling, the starting time is better between 0.5s and 1.0s. The relation between the rise time and the starting time is shown in Fig. 14. The rise time increases gradually with the starting time under all conditions. Figure 15 and Figure 16 describe the gate signals of  $Q_1$ ,  $Q_3$ ,  $Q_4$ , and  $Q_6$  under the conditions of the right turn mode and no-load. Figure 15 shows the case of  $Q_1=90\%$  and  $Q_6=0\%$ . On the other hand, Fig 16 shows the case of  $Q_1=Q_6=90\%$  (the two motors rotate in contrary directions to each other). As for the turning radius, the case of Fig. 15 is 58.2cm and that of Fig.16 is 35.9cm, respectively. These figures also indicate the speed data of the left and the right side wheels. In Fig. 16, the speed of the right side wheel is low compared to the left side one;

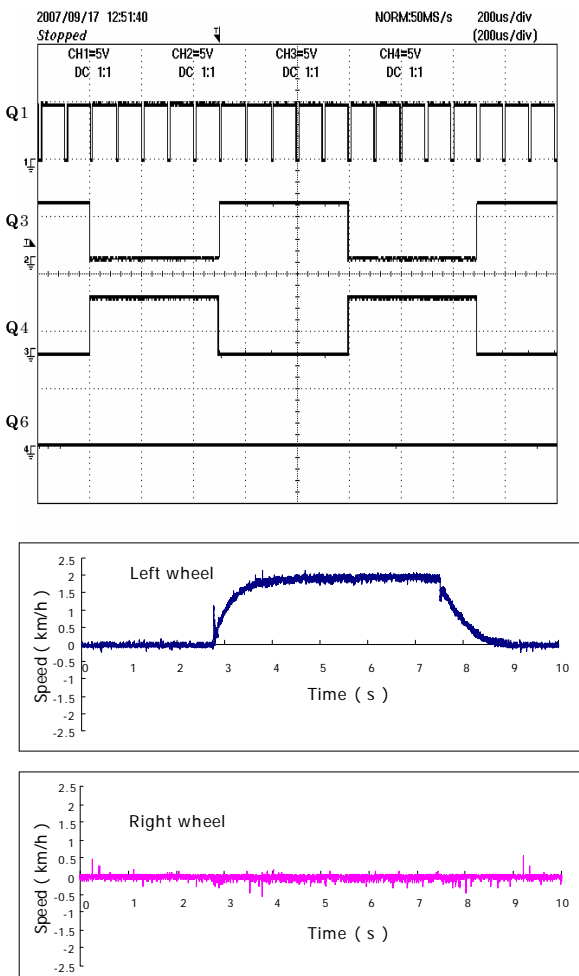

**Fig. 15** Gate signals of MOSFETs and wheel speed (Switching duty ratio:  $Q_1=90\%$ ,  $Q_6=0\%$ )

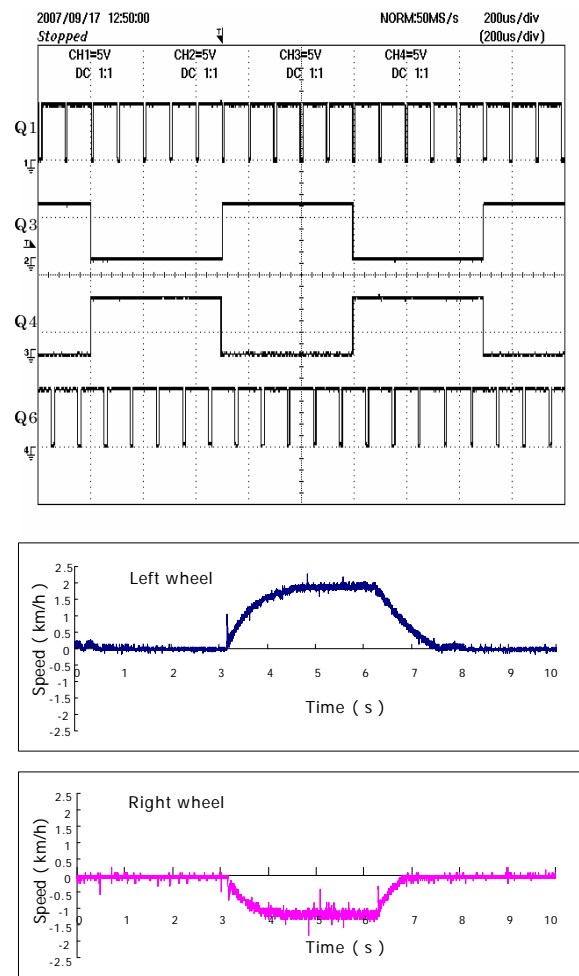

**Fig. 16** Gate signals of MOSFETs and wheel speed (Switching duty ratio:  $Q_1=Q_6=90\%$ )

the reason for this is larger friction of the right side tire when the wheelchair turn right.

According to these experimental results, basic speed characteristics of the electric wheelchair have been examined. Then, it is assured that the wheelchair system fundamentally has satisfactory performance.

## 5. CONCLUSIONS

In this paper, the prototype electric wheelchair using the PEM fuel cell is discussed. The points of the wheelchair system are also utilizing the EDLC bank as an energy buffer and the newly designed four-quadrant DC chopper which drives the two DC motors. Basic drive performance of the wheelchair has been examined by experimental results, considering the essential characteristics of the PEM fuel cell.

As a result, it is shown that the PEM fuel cell can be adapted to the electric wheelchair system, and basic operations of the wheelchair have been achieved.

The next stage of this subject is to examine the management of energy flow among the PEM fuel cell, the EDLC bank, and the two DC motors.

The authors hope that the ideas and technologies which have been investigated by this study will contribute to not only electric wheelchairs but also future electric vehicles and transportation.

## Acknowledgements

We would like to thank Power Systems Co.,Ltd. for providing the EDLCs, and QM Soft Co.,Ltd. for informing us about the PEM fuel cell and the hydrogen storage alloys.

## References

- Hoogers, G., *Fuel Cell Technology Handbook*, CRC Press, USA, 2003.
- Larminie, J., *Fuel Cell Systems Explained (2<sup>nd</sup> Edition)*, John Wiley & Sons Ltd., 2003.
- Iizuka, S., *Possibility of Fuel Cell Cars and Electric Vehicles*, Grand Prix Publisher Co., Ltd., 2006.
- Yamaguchi, S., and T. Ikemoto, Electric Wheelchair Using Ni-MH Battery Aided by Fuel Cell, *Journal of Asian Electric Vehicles*, Vol. 5, No. 2, 1049-1053, 2007.
- Anyapo, C., K. Saito, and T. Noguchi, Development of Electric Wheelchair Using Fuel Cell, *Proceedings of Niigata Branch of IEEJ*, IV-6, 56, 2006.
- Saito, K., C. Anyapo, and T. Noguchi, Development of Electric Wheelchair Using PEM Fuel Cell,

*Proceedings of The International Workshop on Mechatronics*, 44-46, 2006.

Kamjitjam, P., K. Saito, and T. Noguchi, Speed Control of Electric Wheelchair Using Fuel Cell, *Proceedings of Niigata Branch of IEEJ*, II-7, 25, 2007.

Saito, K., P. Kamjitjam, and T. Noguchi, Speed Characteristics of Electric Wheelchair Using PEM Fuel Cell, *Proceedings of The 2<sup>nd</sup> Technology and Innovation for Sustainable Development Conference*, 03\_024\_2008I, 347-351, 2008.